

# Miller–Urey Revisited: When Lightning Strikes the Earth

William Paneral,<sup>†</sup> Brent Leslie,<sup>†</sup> Derek Lovingood,<sup>†</sup> Robert Stapleton,<sup>†</sup> Mike Anderson,<sup>†</sup> Anna McRae,<sup>†</sup> Leri Atwater,<sup>†</sup> Thomas Manning,<sup>\*†</sup> and Dennis Phillips<sup>‡</sup>

*Department of Chemistry, Valdosta State University, Valdosta, GA 31698, tmanning@valdosta.edu, and Chemistry Department, University of Georgia, Athens, Georgia*

*Received February 1, 2002. Accepted March 19, 2002*

**Abstract:** A discharge is arced to different solutions containing the simple molecular species water, methanol, and ammonia. We show that the impact of the discharge at the discharge–solution interface produces a range of organic molecules, including amino acids and polymers containing carboxylate, amine, imine, and cyano groups. The classic Miller–Urey experiment, of which there are hundreds of variations, changing parameters such as gas composition, pressures, and voltage have been tested, involves the production of simple amino acids and other species in the gas phase in an arc discharge. This work's emphasis is the production of various chemical species at a discharge–liquid interface. The analysis of the product is conducted by IR, UV–VIS, LC–MS and MALDI–MS. As a laboratory exercise or a demonstration, this simple derivation of the Miller–Urey experiment can be used in a variety of teaching settings, from high school through advanced undergraduate research classes to demonstrate the basic hypothesis of how life on Earth may have started.

## Introduction

In the classic Miller–Urey experiment, an arc discharge is used to convert simple gas-phase molecules, such as water, methane and ammonia, into simple amino acids [1, 2]. It was originally argued that under primordial conditions the arc discharge replicated lightning and provided the molecular building blocks for evolution. Since that time, research has extended in other directions such as the role of ultraviolet light in the photochemical production of molecular species [3], amino acids found in meteorites and comets [4–6], as well as a large number of investigations into various aspects of molecular evolution [7–20].

In this experiment we tried a similar but fundamentally different approach to converting simple molecular species to larger ones. We arced this discharge directly to a liquid containing simple molecular species (water, ammonia, methanol) in different ratios, atmospheres, and pHs. We justify the use of methanol because methane, which was believed to be in the earliest atmosphere, will produce methanol in the presence of water. The theory presented in this research is that a solution is about 1,000 times denser than a gas and consequently contains a much higher concentration of chemical species. Not only will more species be present to react during the discharge they will be in a more static environment (compared to the gas phase) for additional reactions after the discharge has ceased. In searching the molecular evolution literature, there exists a large body of data stretching decades in which various gas-phase molecular species (H<sub>2</sub>O, NH<sub>3</sub>, CH<sub>4</sub>, O<sub>2</sub>, H<sub>2</sub>, etc.) at various ratios and under varying conditions (voltage, current density, total pressure, etc.) exist [1–20]; however no experimental data exist that we could find where a high voltage discharge strikes a

solid or liquid and the chemical products were analyzed for the basic building blocks of life.

Typically, Miller–Urey is introduced in biology classes, but this experiment was conducted as an exploratory laboratory in physical chemistry. In addition to the experimental work described below, students were asked to calculate heats of reaction for the various products formed (glycine, urea, etc.) using both bond energies obtained from various texts and heats of formation obtained from the NIST webpage (<http://webbook.nist.gov/chemistry/>).

As with any evolution discussion, this was presented as a scientific hypothesis and not fact. We discussed that while this experiment showed how some of the building blocks of life could be formed not only on earth but also on other planets in our solar system or others, it did not show how inert chemicals combine to form a living organism. In order to balance all concerns on this delicate issue but also present an intriguing experiment, it was important to clearly discuss what science had and had not been able to replicate in the laboratory.

## Experimental

The experimental apparatus (see figure 1) was sealed at ambient pressure and temperature and with different atmospheres (air, N<sub>2</sub>, Ar). A Tesla coil that discharged at 0.5 MHz and 50 kV was placed approximately 1 cm above the liquid (50 mL total volume) and allowed to run for time durations of 3 to 24 hours (see Figure 1). We should note that running the Tesla coils for extended periods of time shortened their life times. Infrared measurements of dried samples were made using a Mattson FTIR spectrometer and 3M IR cards. A Perkin–Elmer Lambda II UV–VIS spectrometer was used for solution absorbance measurements. The resulting solutions had to be diluted between 5 and 50 fold to bring solution absorbance measurements on scale. A pH measurement was made of aqueous-phase mixtures (i.e. water and NH<sub>3</sub>) and then methanol was added and the pH adjusted by a dilution calculation. Dilute solutions (0.1 M or less) of NaOH and HCl were used to adjust pH. The first series of experiments involved mixtures of water, ammonia (1.0 M NH<sub>3</sub> starting concentration), and

\* Address correspondence to this author.

<sup>†</sup> Valdosta State University

<sup>‡</sup> University of Georgia

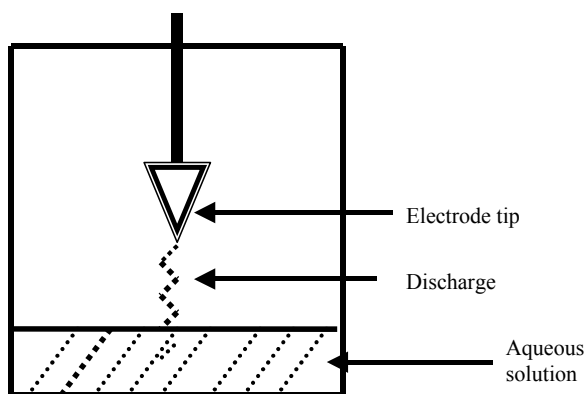

**Figure 1.** A simplified schematic of the experimental apparatus used in this work. A Tesla coil is used to generate the discharge or plasma in a sealed container. Running the discharge for 24 hr continuously delivers less energy to the solution than a single lightning strike would impart.

methanol at different ratios. The concentration of water (v/v %) ranged from 60 to 90%, ammonia from 5 to 20%, and methanol from 5 to 20% and was tested at a pH of 10. Four other pHs (2.0, 5.0, 7.0, 8.5) were also tested. Three atmospheres (air, nitrogen, argon) were tested on a single water (80%), methanol (10%), and ammonia (10%) mixture and no statistical changes were found. Mass Spectrometer measurements were made at The Chemical and Biological Sciences Mass Spectrometry Facility at the University of Georgia. The LC-MS is an Applied Biosystems (ABI) solvent delivery system connected to a PE Sciex API I plus mass spectrometer equipped with an electrospray source. The MALDI is a Reflex produced by Bruker Daltonics. The matrix used was a saturated solution of  $\alpha$ -cyano-4-hydroxycinnamic acid (Sigma) in a 50:50 solution of acetonitrile:water and 0.1% trifluoroacetic acid. The solutions typically underwent aggregation and precipitation after a matter of days so no percent yield measurements were attempted. Controls, which consist of untreated MeOH/H<sub>2</sub>O/NH<sub>3</sub> mixtures, were used for IR, UV, and MS background correction measurements. Standards of urea, glycine, glycineamide, etc. were used as well for qualitative identification.

## Results and Discussion

The infrared spectra of all products contained broad spectral features observed in simple amino acids (3400 cm<sup>-1</sup>, N-H; 1700 cm<sup>-1</sup>, C=O, etc). UV-VIS absorbance measurements were also made of each sample and compared to the nineteen amino acid standards used. The spectra gave no definitive qualitative identification of a single species but did consistently have spectral peaks at 211 nm, matching a spectral feature routinely observed in the standards. While not providing definitive qualitative or quantitative identification, these infrared and ultraviolet spectroscopic data provide preliminary evidence the experimental apparatus was producing amino acids.

The Liquid Chromatography-Mass Spectrometric (LC-MS) and Matrix-Assisted Laser Desorption Ionization-Mass-Spectrometric (MALDI-MS) analysis identified a range of molecular species including isocyanatomethane, methylnitrate, *N*-methoxymethanamine, urea, glycine, glycinamide, methylurea, *N,N*-dimethylurea, ethylurea, alanine, guanine, serine, and *N-tert*-butylmethacrylamide. With LC-MS, we typically observed several peaks eluting from the column over a thirty-minute window. Each peak would typically contain a number

of slices whose mass spectrum was different, indicating a range of polymeric forms were present. We concentrated on identifying simple molecular species and molecular fragments that could potentially be building blocks for polymers of biological interest (peptides, etc.).

From these data we elected to vary the solution content and ratios and found that changes in concentrations of NH<sub>3</sub> and MeOH clearly affected the formation kinetics of the simple species mentioned. Specifically, lowering the concentration of ammonia from 20 to 5% in 5% increments, while holding the methanol constant and raising the water v/v %, resulted in the two predominant IR bands (3400 cm<sup>-1</sup>, 1600 cm<sup>-1</sup>) increasing at a slower rate that mimicked a pseudo-first-order reaction. Although the overall aminocarboxylate production increased, we did not attempt to correlate the kinetics with a specific species. When a discharge with high temperature (3,000 to 10,000 K), high electron and ion density (10<sup>14</sup> to 10<sup>15</sup> cm<sup>-3</sup>), and high voltage (10 to 50 kV) strikes a liquid surface, a complex level of chemistry takes place at the interface and in the surrounding solution and gas phase. The synthesis of molecules in the discharge or plasma phase that have been studied in detail include fullerenes (C<sub>60</sub>, buckyballs) [21, 22] and ozone (O<sub>3</sub>) [23-25]. Although the specific species may vary, they share a common thread. The kinetic energy of the discharge or plasma breaks most bonds, resulting in free atoms (i.e., H, C, N, O, etc.), atomic ions (H<sup>+</sup>, C<sup>+</sup>, O<sup>+</sup>, O<sup>2+</sup>, etc.), and multiply bonded (i.e., triple) molecular species that are stable for a brief period of time in the high temperature environment (i.e., N<sub>2</sub><sup>+</sup>, C<sub>2</sub>, C<sub>2</sub><sup>+</sup>, etc.) of a plasma.

These species diffuse from the high temperature region to less energetic regions of the discharge and recombine to produce various molecular species that are stable under ambient conditions. For the production of glycine, among the simplest molecules produced in the reactions described here, the overall reaction might be:

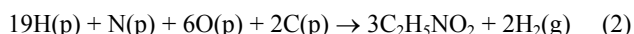
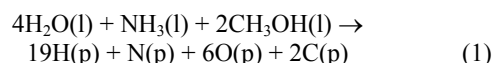

where p is the plasma or discharge state.

But the specific reactions and intermediates, which would include species like H<sup>+</sup>, O<sub>2</sub><sup>+</sup>, O<sub>2</sub><sup>-</sup>, O, O<sup>+</sup>, etc, are not known at this point and substantial spectroscopic work would be needed to unlock the mechanism. In one series of runs we varied the pH (3, 5.5, 7, 10) and showed that in acidic environments (pH = 3, 5.5), there was minimal production of any amino-carboxylate-based species, while the most basic system (pH = 10), reacted the quickest. This indicates the presence and subsequent volatility of NH<sub>3</sub> at higher pHs (7,10) plays a role in the synthesis of various aminocarboxylates while the nonvolatile NH<sub>4</sub><sup>+</sup> species present in acidic solutions does not provide a significant amount of nitrogen in eqs 1 and 2 above.

Our experimental evidence for the various mixtures previously mentioned indicates several functional groups play a role in either the synthesis or structure of the products including carboxylates (RCOO<sup>-</sup>), amines, imines, C≡N, C≡C, and nitro (-NO<sub>2</sub>).

Patterns for the addition of CO<sub>2</sub> were common in all solutions. For example, Figure 2a illustrates the mass spectrum of the product of eight hours of discharge contact with a water,

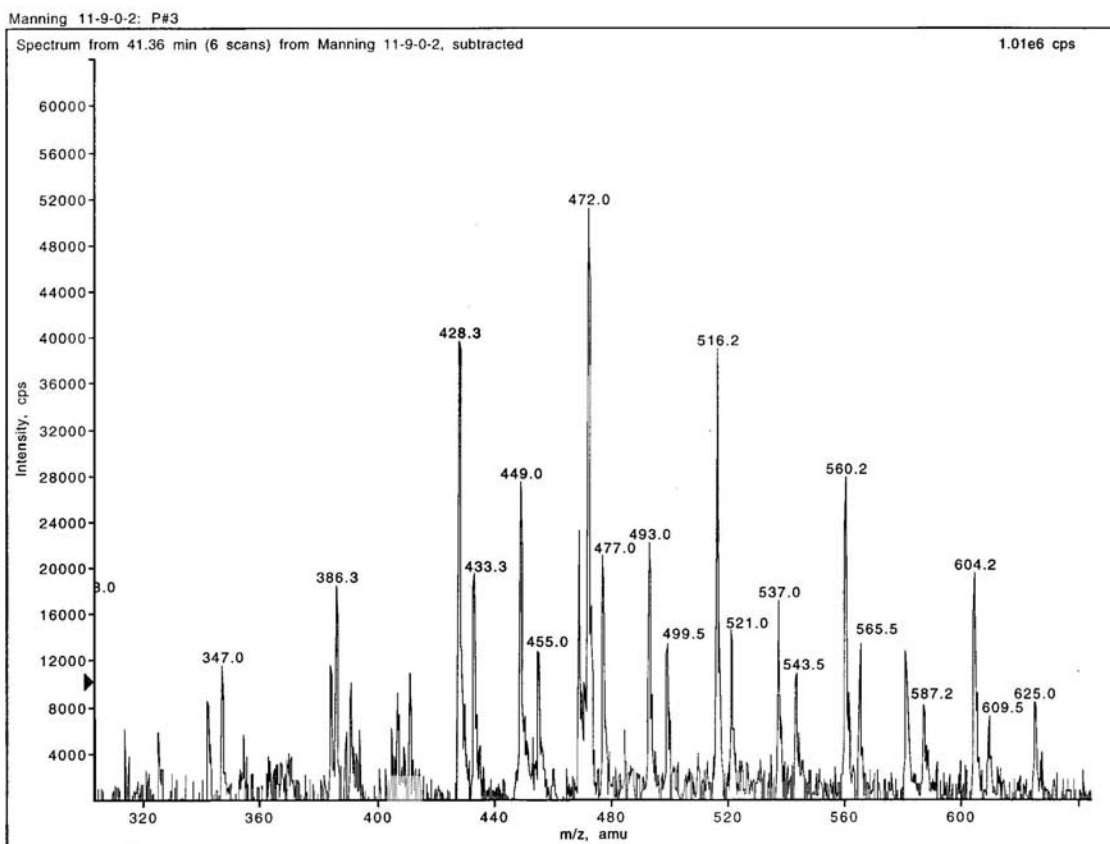
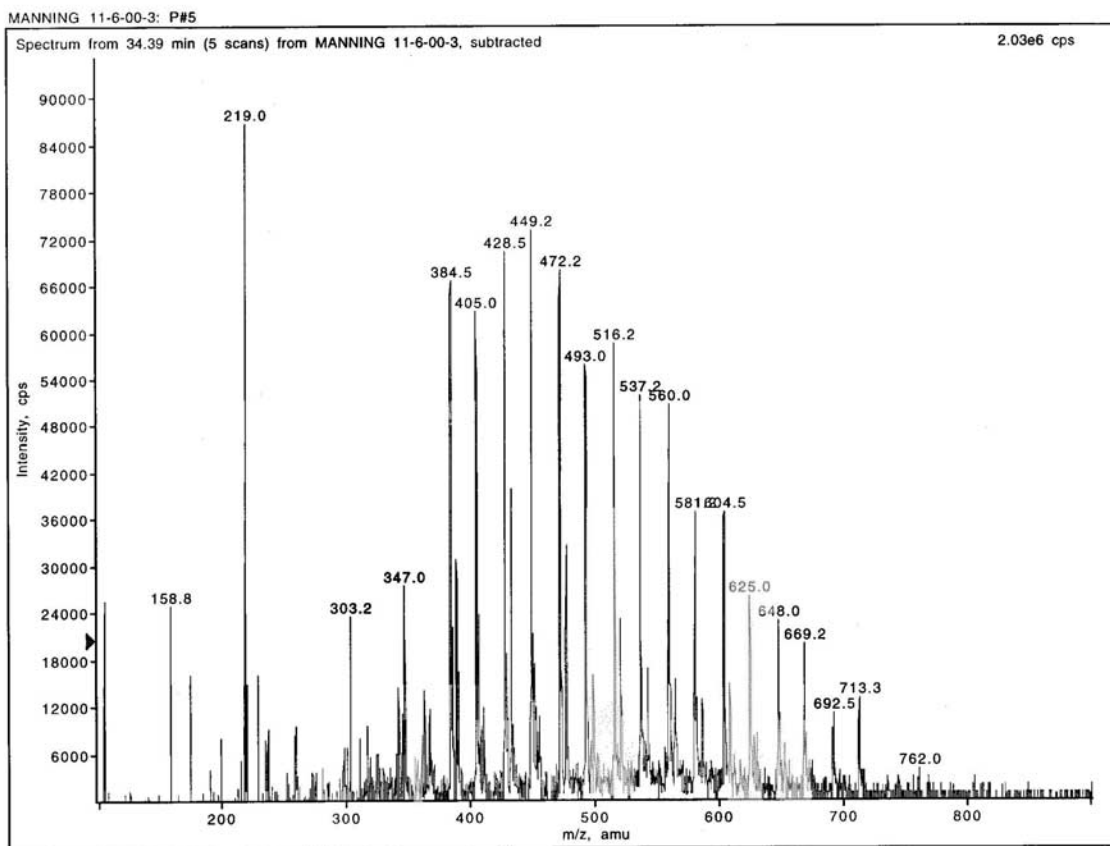

**Figure 2.** (a) A mass spectrum from LC-MS illustrates a series of fragments that differ by the gain of  $\text{CO}_2$  (mass 44 amu). (b) This spectrum also illustrates the systematic gain of mass 44 from fragments produced during the discharge-solution contact.

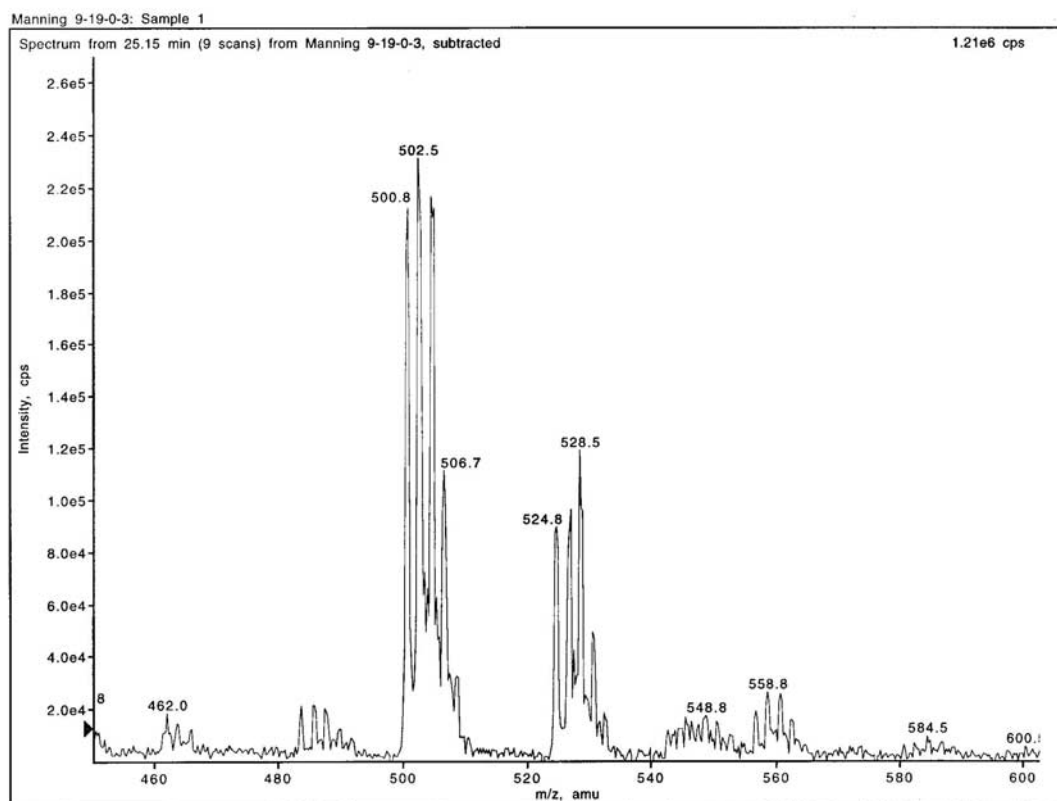
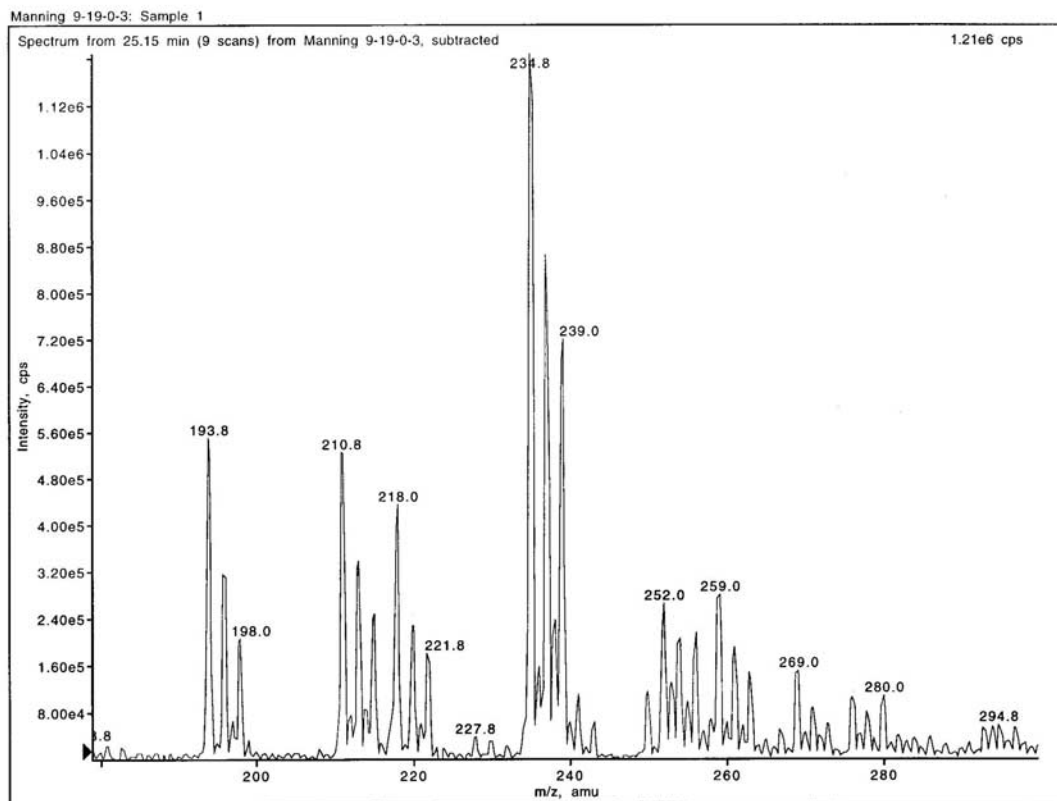

**Figure 3.** (a) A mass spectrum from LC-MS illustrates a loss of  $\text{-NH}_3$  (mass 17 amu) as well as a loss of  $\text{H}_2$  in a condensation reaction that leads to an imine (b) The loss of  $\text{H}_2$  due to the formation of an imine group accounts for the fragments with (N-2) masses illustrated in these mass spectra obtained by LC-MS.

methanol, and ammonia solution and illustrates the systematic gain of mass 44 from 428 u to 692 u. Figure 2b shows the loss of mass 44 from two aqueous phase fragments (713, 669, 625, 581, 537, 493, 449 u and 692, 648, 604, 560, 516, 472, 428 u).

Second, imine formation and amination/deamination was found in simple water/MeOH/ammonia solution on fragments of various sizes. For example, our interpretation of Figure 3 is peaks at 252, 254, and 256 are the same structure separated by the loss of H<sub>2</sub>. This 252, 254, 256 series can be related to the more prominent 235, 237 and 239 series by the gain/loss of NH<sub>3</sub>, as well as the mass spectral peaks at 218, 220, and 222 u. Specifically, the 252, 235 and 218 u peaks are fragments of the same structure, except for the gain or loss of NH<sub>3</sub>. The same trend applies for the 254, 237, and 220 u series, and the 256, 239, and 222 u series. Larger mass fragments (Figure 3a and b) also presented evidence for imine formation. Third, IR measurements provided evidence for the presence of C≡N, –NO<sub>2</sub>, and C=C bond formations in solutions but the data did not provide evidence for the addition or loss of –NO<sub>2</sub> or C≡N groups.

In this laboratory exercise, in addition to identifying species by IR, UV–VIS, and mass spectroscopy, students wrote out balanced equations and calculated the heats of reactions ( $\Delta H_{\text{rxn}}$ ) for nineteen amino acids and urea from water, methanol, and ammonia using bond energies (BE) and heats of formation ( $\Delta H_f^\circ$ ).

As a lab exercise for a chemistry class, this could be conducted at three levels:

**Demonstration.** It takes between 6 and 10 hr for the clear water/methanol/ammonia solution to turn yellow. Using a ring stand to support the Tesla coil over the solution and left in a hood over night, the visual effect of changing colors is easily demonstrated in a basic solution. Also, it is common for white tentacles to grow from the electrode surface during this process. Once the system is shut down, these tentacles quickly melt in a matter of minutes. It is evidence of a solid that exists with a relatively high voltage and current running through it but quickly disappears under ambient conditions. In our discussions, we hypothesized that some of the building blocks of life might have also formed on particulate matter charged during a lightning strike. The only quantitation that takes place is visually in this level.

**Spectroscopic Quantitation.** Running the experiment overnight and analyzing the product by infrared spectroscopy and/or UV–VIS spectroscopy can easily help identify the major functional groups formed.

**Mass Spectral Identification.** If access to a mass spectrometer system (LC–MC, MALDI–MS, FT–ICR, etc.) is possible, a range of conditions can be varied and the results analyzed. For example, different ionic strengths or mineral content (CaCO<sub>3</sub>, FeS, etc.) can be tested and the simple molecules and polymers identified.

## Conclusion

In any given experiment, a large number of molecular and polymeric species were produced that were not present in the controls. The molecular and mineral species combinations and ratios possible over the surface of a planet that can be easily replicated with this experimental design coupled with the variations in discharge conditions (voltage, current, ion and electron density, discharge frequency, atmospheric content,

etc) may provide the different chemical species needed for life to evolve from primordial conditions not observed with the Miller–Urey setup. The work by students in this exploratory laboratory was centered on determining the structures of various molecular and polymeric forms found in some of the simpler systems produced at or near the interface of the plasma and liquid. We were able to use LC–MS and MALDI–MS to positively identify some smaller, biologically relevant species but additional separation, isolation and structural identification would be needed to identify polymeric species present. In physical chemistry, it offers a simple experimental opportunity to run an experiment of some historical importance in which the chemical bonds are clearly broken and reformed. This opens the possibilities for a series of exercises attempting to deduce a reaction mechanism from bond energies or heats of formation.

Other researchers have used contact glow discharges as a possible explanation for prebiotic synthesis of amino acids [26]. A glow discharge produces a plasma or discharge of much lower temperature, energy, electron and ion density, etc. than the arc from a Tesla coil.

**Acknowledgment.** The VSU Foundation and Chemistry Department are thanked for their support. Discussions with Dr. Jim Nienow and Dr. Linda Chamberlin of the VSU Biology department were helpful and greatly appreciated. Discussions with Dr. John Chalmers of the University of California at San Diego have been extremely helpful.

## References and Notes

1. Miller, S. L. A production of Amino Acids Under Possible Primitive Earth Conditions. *Science*, **1953**, *117*, 528–529.
2. *Earth's Earliest Biosphere: Its Origin and Evolution*; Schopf, J. W., Ed.; Princeton University Press: Princeton, NJ, 1983.
3. Tielens, A. G.; Charnley, S. B.; Origins of Life and Evolution of the Biosphere, **1997**, *27*, 23–51.
4. Cronin, J. R.; Pizzarello, S. Enantiometric Excesses in Meteorite Amino Acids. *Science* **1997**, *275*, 951–955.
5. Pizzarello, S.; Cronin, J. R. Alanin Enantiomers in the Murchinson Meteorite. *Nature* **1998**, *394*, 236.
6. Thomas, P. J.; Chyba, C. F.; McKay C. P. *Comets and the Origin and Evolution of Life*; Springer-Verlag: New York, 1997.
7. Freeland, S. J.; Knight, R. D Do Proteins Predate DNA. *Science* **1999**, *286*, 690–692.
8. Palmer, J. D. A Single Birth of All Plastids. *Nature* **2000**, *405*, 32–33.
9. Knoll, A. H. A New Molecular Window on Early Life. *Science* **1999**, *285*, 1025–1026.
10. Nei, M.; Zhang, J. Z. Molecular Origins of Species. *Science* **1998**, *282*, 1428–1429.
11. Lewin, R.; Paabo S. A Revolution in Evolution. *Nature* **1997**, *386*, 456–456.
12. Sharp, P. M. In Search of Molecular Darwinism. *Nature* **1997**, *385*, 111–112.
13. Service, R. F. Just How Old Is That DNA Anyway. *Science* **1996**, *272*, 810–810.
14. Mooers, A. O.; Redfield R. J. Digging Up the Roots of Life. *Nature* **1996**, *379*, 587–588.
15. Morell, V. Proteins “Clock” the Origins of All Creatures—Great and Small *Science* **1996**, *271*, 448–448.
16. Ferris, J. P. Life at the Margins. *Nature* **1995**, *373*, 659–659.
17. Stewart, C. B. Active Ancestral Molecules. *Nature* **1995**, *374*, 12–13.

18. Roger, A. J.; Doolittle, W. F. Why Introns-in-Pieces? *Nature* **1993**, *364*, 289–290.
19. Doolittle, W. F.; Stoltzfus, A. Genes-in-Pieces Revisited. *Nature* **1993**, *361*, 403–403.
20. Gillespie, J.; Charlesworth, B. Molecular Panselctionism. *Science* **1992**, *257*, 420–421.
21. Manning, T. J.; Mitchell, M.; Stach, J.; Vickers, T. Synthesis of Exfoliated Graphite from Fluorinated Graphite Using an Atmospheric-Pressure Argon Plasma. *Carbon* **1999**, *37*, 1159.
22. Manning, T. J.; Noel, A.; Mitchell, M.; Miller, A.; Grow, W.; Gaddy, G.; Riddle, K.; Taylor, K. Stach, J. Impulse Heating an Intercalated Compound using a 27.12 MHz Atmospheric Inductively Coupled Argon Plasma to Produce Nanotubular Structure. In *Science and Application of Nanotubes*, Fundamental Materials Research Series; Tomanek, D., Ed.; Plenum Publishing: New York, 2000.
23. Manning, T. J. Production of Ozone in an Electrical Discharge Using Inert Gases as Catalysts. *Ozone: Sci. Eng.* **2000**, *22* (1), 53–65.
24. Manning, T. J. Inert Gases as Catalyst for Ozone Generation. US Patent 6,022,456, Feb 8, 2000.
25. Manning, T. J. Production of Ozone in an Electrical Discharge Using Inert Gases as Catalysts. *Ozone: Sci. Eng.* **2000**, *22* (1), 53–65.
26. Harada, K., Suzuki, S., Ishida, H., Matsuyama, M., Tamura, M. Amino Acid Synthesis by Contact Glow Discharge Electrolysis, *Origins of Life* **1978**, *1*, 141–151.